



深圳市拓普微科技开发有限公司

SHENZHEN TOPWAY TECHNOLOGY CO., LTD.

LMT070DAMFWA-NFD

LCD Module User Manual

Prepared by: Yao gang Date: 2019-11-02	Checked by: Date:	Approved by: Date:
---	----------------------------------	-----------------------------------

Rev.	Descriptions	Release Date
0.1	Preliminary release	2019-08-06
0.2	Update Optical Characteristics	2019-11-02

Table of Content

1. General Specification	3
2. Block Diagram.....	3
3. Terminal Function.....	4
3.1 K1 Power Terminal.....	4
3.2 K2 HDMI Terminal.....	4
3.3 K3 VGA Terminal	5
3.4 K4 Touch Panel Controller Terminal	5
4. Absolute Maximum Ratings	5
5. Electrical Characteristics	6
5.1 Driving TFT LCD Panel	6
5.2 Driving Touch Panel.....	6
6. Optical Characteristics	6
7. LCD Module Design and Handling Precautions-----	8
8. CTP Mounting Instructions-----	9
9. RTP Mounting Instructions-----	10

1. General Specification

Signal Interface : VGA/HDMI
 Display Mode : Transmissive / Normal Back
 Screen Size(Diagonal) : 7.0"
 Outline Dimension : 193.0 x 112.0 x 18.3 max (mm)
 (see attached drawing for details)
 Active Area : 154.21 x 85.92 (mm)
 Color Depth: 16.7M
 Number of dots : 1024 x 600
 Pixel Pitch : 0.1506×0.1432 (mm)
 Pixel Configuration : RGB Vertical Stripe
 Backlight : LED
 Surface Treatment : HC
 Viewing Direction : ALL
 Operating Temperature : 0 °C ~ +50°C
 Storage Temperature : -10°C ~ +60°C

Note:

- *1. For saturated color display content (eg. pure-red, pure-green, pure-blue or pure-colors-combinations).
- *2. For “color scales” display content.
- *3. Color tone may slightly change by temperature and driving condition.

2. Block Diagram

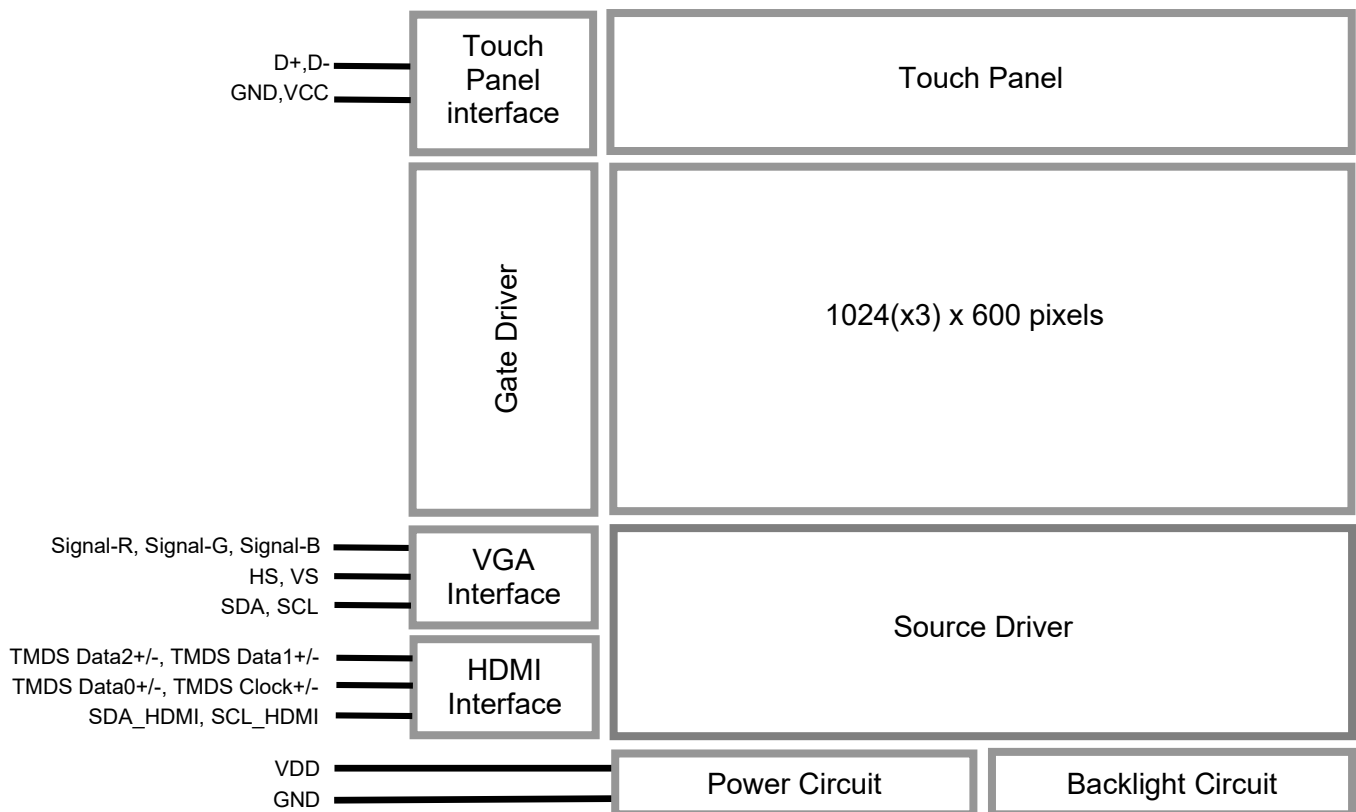

3. Terminal Function

3.1 K1 Power Terminal

Pin No.	Pin Name	IO	Descriptions
1	VDD	Power	Positive Power Supply(12.0V)
2	VDD	Power	Positive Power Supply(12.0V)
3	NC	-	No connection
4	NC	-	No connection
5	GND	Power	Power Supply GND (0V)
6	GND	Power	Power Supply GND (0V)

3.2 K2 HDMI Terminal

Pin No.	Pin Name	IO	Descriptions
1	TMDS Data2+	Input	HDMI receiver positive signal channel 2
2	TMDS Data2 Shield	Power	Signal Ground
3	TMDS Data2-	Input	HDMI receiver negative signal channel 2
4	TMDS Data1+	Input	HDMI receiver positive signal channel 1
5	TMDS Data1 Shield	Power	Signal Ground
6	TMDS Data1-	Input	HDMI receiver negative signal channel 1
7	TMDS Data0+	Input	HDMI receiver positive signal channel 0
8	TMDS Data0 Shield	Power	Signal Ground
9	TMDS Data0-	Input	HDMI receiver negative signal channel 0
10	TMDS Clock+	Input	HDMI receiver positive signal clock
11	TMDS Clock Shield	Power	Signal Ground
12	TMDS Clock-	Input	HDMI receiver negative signal clock
13	NC	-	No connection
14	NC	-	No connection
15	SCL_HDMI	Input	Serial data clock
16	SDA_HDMI	Output	Serial data out
17	GND	Power	Signal Ground
18	+5V Power	Power	Power supply for DDC memory
19	Hot Plug Detect	Output	Hot Plug Detect signal

Note:

1. HDMI terminal should be well connect before power on (hot-plug is not allowed)
2. Support Standard HDMI Signal, from PC:
 - 800x600,60Hz
 - 1024x600,60Hz
 - 1024x768,60Hz

3.3 K3 VGA Terminal

Pin No.	Pin Name	IO	Descriptions
1	GND	Power	Signal Ground
2	VS	Input	Analogue VGA Vertical Sync signal input
3	HS	Input	Analogue VGA Horizontal Sync signal input
4	GND	Power	Signal Ground
5	Signal-R	Input	Analogue VGA Red signal input
6	GND	Power	Signal Ground
7	Signal-G	Input	Analogue VGA Green signal input
8	GND	Power	Signal Ground
9	Signal-B	Input	Analogue VGA Blue signal input
10	GND	Power	Signal Ground
11	SDA	Output	Serial data out
12	SCL	Input	Serial data clock

Note:

1. VGA terminal should be well connect before power on (hot-plug is not allowed).
2. Support Standard VGA Signal, from PC:
 - 800x600,60Hz
 - 1024x600,60Hz
 - 1024x768,60Hz

3.4 K4 Touch Panel Controller Terminal

Pin No.	Pin Name	I/O	Descriptions
1	GND	Power	Ground
2	VCC	Power	Positive Power Supply(5.0V)
3	GND	Power	Ground
4	D+	I/O	USB D+ signal
5	D-	I/O	USB D- signal
6	NC		
7	NC		
8	NC		
9	NC		
10	NC		

4. Absolute Maximum Ratings

Top=25°C, VDD =12.0V ,GND=0V

Items	Symbol	Min.	Max.	Unit	Condition
Power Supply Voltage	VDD	-0.3	+13.0	V	
Operating Temperature	T _{OP}	0	50	°C	No Condensation
Storage Temperature	T _{ST}	-10	60	°C	No Condensation

Note:

- *1. This rating applies to all parts of the module. And should not be exceeded.
- *2. The operating temperature only guarantees operation of the circuit. The contrast, response speed, and the other specification related to electro-optical display quality is determined at the room temperature, T_{OP}=25°C.
- *3. Ambient temperature when the backlight is lit (reference value).
- *4. Any Stresses exceeding the Absolute Maximum Ratings may cause substantial damage to the device. Functional operation of this device at other conditions beyond those listed in the specification is not implied and prolonged exposure to extreme conditions may affect device reliability.

5. Electrical Characteristics

5.1 Driving TFT LCD Panel

Top=25°C, VDD =12.0V ,GND=0V

Items	Symbol	MIN.	TYP.	MAX.	Unit	Note
Supply Voltage	VDD	11.5	12.0	12.5	V	
VDD Power Consumption	I _{VDD}	-	215	-	mA	

5.2 Driving Touch Panel

Top=25°C, VCC =5.0V ,GND=0V

Items	Symbol	MIN.	TYP.	MAX.	Unit	Note
Supply Voltage	VCC	4.8	5.0	5.2	V	
Operating Current	I _{VCC}	-	21.8	-	mA	

6. Optical Characteristics

Item	Symbol	Condition	MIN.	TYP.	MAX.	UNIT	Note.
Viewing angle	θ _U	(CR≥10)	70	85	-	Degree	Note 2
	θ _D		70	85	-		
	θ _L		70	85	-		
	θ _R		70	85	-		
Contrast ratio	CR	θ=0°	600	800	-	-	Note 1,3
Response Time	T _{on}	25°C	-	25	35	msec	Note 1,4
	T _{off}					msec	
Chromaticity	White	X	Backlight is on	0.265	0.315	0.365	Note 1,5
		Y		0.296	0.346	0.396	
	Red	X		0.538	0.588	0.638	
		Y		0.300	0.350	0.400	
	Green	X		0.286	0.336	0.386	
		Y		0.544	0.594	0.644	
	Blue	X		0.099	0.149	0.199	
		Y		0.061	0.111	0.161	
Luminance	L		-	272	-	cd/m ²	Note 1,6
NTSC			-	50	-	%	Note 5
Luminance uniformity	U		-	75	-	%	Note 1,7

Test Conditions:

1. IF= 120 mA, VF=9.6V, and the ambient temperature is 25. °C
2. The test systems refer to Note 1 and Note 2.

Note 1:

The data are measured after LEDs are turned on for 5 minutes. LCM displays full white. The brightness is the average value of 9 measured spots. Measurement equipment SR-3A (1°)

Measuring condition:

- Measuring surroundings: Dark room
- Measuring temperature: Ta=25°C.
- Adjust operating voltage to get optimum contrast at the center of the display.

Note 2:

The definition of viewing angle:

Refer to the graph below marked by θ and ϕ

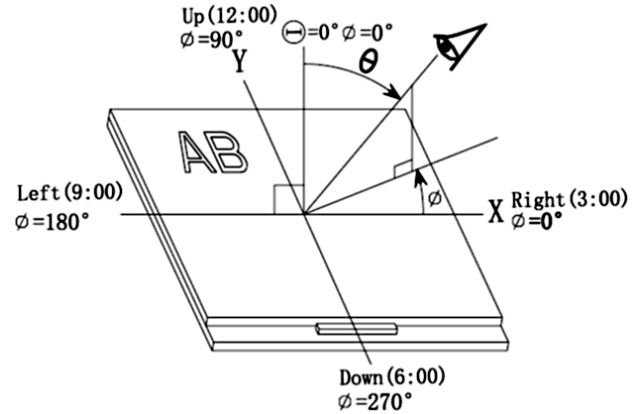

Note 3:

The definition of contrast ratio (Test LCM using SR-3A (1°)):

$$\text{Contrast Ratio (CR)} = \frac{\text{Luminance When LCD is at "White" state}}{\text{Luminance When LCD is at "Black" state}}$$

(Contrast Ratio is measured in optimum common electrode voltage)

Note 4:

Definition of Response time. (Test LCD using BM-7A(2°)):

The output signals of photo detector are measured when the input signals are changed from "black" to "white"(falling time) and from "white" to "black"(rising time), respectively. The response time is defined as the time interval between the 10% and 90% of amplitudes. Refer to figure as below.

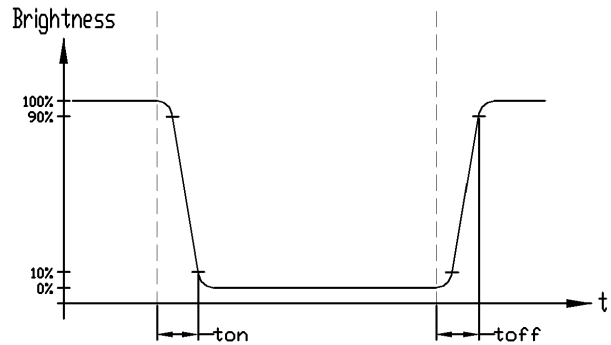

Note 5:

Definition of Color of CIE1931 Coordinate and NTSC Ratio.

Color gamut:

$$S = \frac{\text{Area of RGB triangle}}{\text{Area of NTSC triangle}} \times 100\%$$

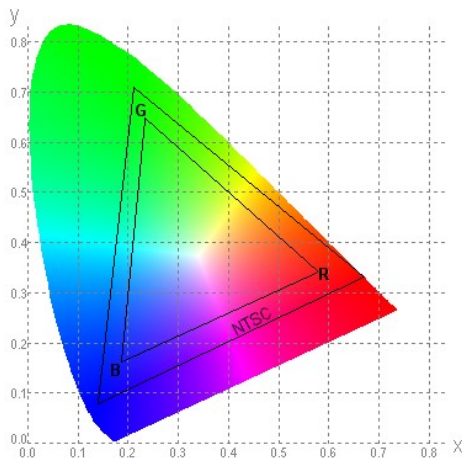

Note 6:

The luminance uniformity is calculated by using following formula.

$$\Delta Bp = Bp (\text{Min.}) / Bp (\text{Max.}) \times 100 (\%)$$

Bp (Max.) = Maximum brightness in 9 measured spots

Bp (Min.) = Minimum brightness in 9 measured spots.

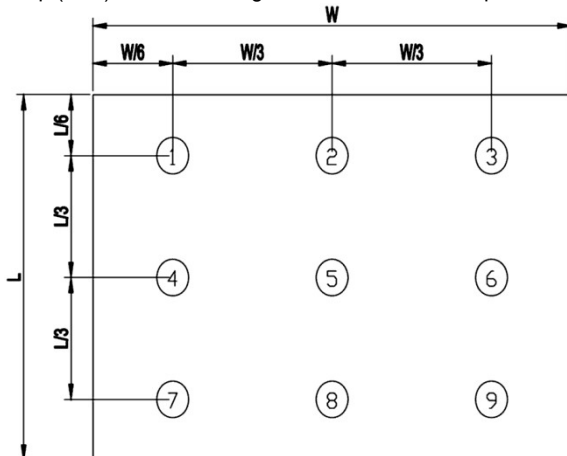

Note 7:

Measured the luminance of white state at center point

7. LCD Module Design and Handling Precautions

- Please ensure V0, VCOM is adjustable, to enable LCD module get the best contrast ratio under different temperatures, view angles and positions.
- Normally display quality should be judged under the best contrast ratio within viewable area. Unexpected display pattern may come out under abnormal contrast ratio.
- Never operate the LCD module exceed the absolute maximum ratings.
- Never apply signal to the LCD module without power supply.
- Keep signal line as short as possible to reduce external noise interference.
- IC chip (e.g. TAB or COG) is sensitive to light. Strong light might cause malfunction. Light sealing structure casing is recommended.
- Make sure there is enough space (with cushion) between case and LCD panel, to prevent external force passed on to the panel; otherwise that may cause damage to the LCD and degrade its display result.
- Avoid showing a display pattern on screen for a long time (continuous ON segment).
- LCD module reliability may be reduced by temperature shock.
- When storing and operating LCD module, avoids exposure to direct sunlight, high humidity, high or low temperature. They may damage or degrade the LCD module.
- Never leave LCD module in extreme condition (max./min storage/operate temperature) for more than 48hr.
- Recommend LCD module storage conditions is 0 C~40 C <80%RH.
- LCD module should be stored in the room without acid, alkali and harmful gas.
- Avoid dropping & violent shocking during transportation, and no excessive pressure press, moisture and sunlight.
- LCD module can be easily damaged by static electricity. Please maintain an optimum anti-static working environment to protect the LCD module. (eg. ground the soldering irons properly)
- Be sure to ground the body when handling LCD module.
- Only hold LCD module by its sides. Never hold LCD module by applying force on the heat seal or TAB.
- When soldering, control the temperature and duration avoid damaging the backlight guide or diffuser which might degrade the display result such as uneven display.
- Never let LCD module contact with corrosive liquids, which might cause damage to the backlight guide or the electric circuit of LCD module.
- Only clean LCD with a soft dry cloth, Isopropyl Alcohol or Ethyl Alcohol. Other solvents (e.g. water) may damage the LCD.
- Never add force to components of LCD module. It may cause invisible damage or degrade the module's reliability.
- When mounting LCD module, please make sure it is free from twisting, warping and bending.
- Do not add excessive force on surface of LCD, which may cause the display color change abnormally.
- LCD panel is made with glass. Any mechanical shock (e.g. dropping from high place) will damage the LCD module.
- Protective film is attached on LCD screen. Be careful when peeling off this protective film, since static electricity may be generated.

7. 液晶显示模块设计和使用须知

- 请注意 V0, VCOM 的设置, 以确保液晶显示模块在不同的使用温度下以及在不同的视角和位置观察模块显示, 均能达到最佳对比度, 请务必将应用电路上设置为对比度可调。
- 请注意液晶显示模块的显示品质判定是指在正常对比度下以及视窗 (V. A) 范围内进行的, 非正常对比度下液晶可能会出现非预期的显示不良, 应注意区分。
- 请勿在最大额定值以外使用液晶显示模块。
- 请勿在没有接通电源的条件下, 给液晶显示模块输送信号。
- 请尽可能缩短信号线的连接, 以避免对液晶显示模块的信号干扰。
- 集成电路因 IC 芯片 (如 TAB 或 COG) 对紫外线极为敏感, 强光环境下可能会引起液晶显示模块功能失效, 故应采用不透光的外壳。
- 请在液晶显示模块与外壳之间保留足够的空间 (可使用衬垫), 以缓冲外力对液晶显示模块的损坏或因受力不均而产生的显示不均匀等异常现象。
- 避免液晶显示屏在某一画面下长时间点亮, 否则有出现残影的风险; 请通过软件每隔一段时间改变一次画面。
- 液晶显示模块的可靠性可能因温度冲击而降低。
- 请勿在阳光直射、高湿、高温或低温下储存和使用液晶显示模块, 这将造成液晶显示模块的损坏或失效。
- 请勿在极限环境 (最大/最小存储/工作温度) 下使用或放置液晶显示模块超过 48 小时以上。
- 液晶显示模块建议存储条件为: 0 C~40 C <80%RH。
- 请勿让液晶显示模块存储于带有酸性、碱性、有害气体环境之中。
- 在运输过程中, 请勿让液晶显示模块跌落与猛烈震动, 同时避免异常挤压, 高湿度, 与阳光照射。
- 液晶显示模块极易受静电损坏, 请务必保证液晶显示模块在防静电的工作环境中使用或保存。(如: 烙铁正确接地, 等)
- 拿取液晶显示模块时需注意操作人员的接地情况。
- 请手持液晶显示模块的边沿取放模块, 防止热压纸或 TAB 部位受力。
- 焊接液晶模块时, 请注意控制烙铁的温度、焊接时间, 以免烫坏导光板或偏光片, 导致显示不均匀等不良现象发生。
- 请勿使用洗板水等腐蚀性液体接触液晶模块, 以免腐蚀导光板或模块电路。
- 仅可使用柔软的干布, 异丙醇或乙醇清洁液晶屏表面, 其他任何溶剂 (如: 水) 都有可能损坏液晶模块。
- 请勿挤压液晶显示模块上的元器件, 以避免产生潜在的损坏或失效而影响产品可靠性。
- 装配液晶显示模块时, 请务必注意避免液晶显示模块的扭曲或变形。
- 请勿挤压液晶显示屏表面, 这将导致显示颜色的异常。
- 液晶屏由玻璃制作而成, 任何机械碰撞 (如从高处跌落) 均有可能损坏液晶显示模块。
- 液晶屏表面带有保护膜, 揭除保护膜时需要注意可能产生的静电。

- Polarizer on LCD gets scratched easily. If possible, do not remove LCD protective film until the last step of installation.
- When peeling off protective film from LCD, static charge may cause abnormal display pattern. The symptom is normal, and it will turn back to normal in a short while.
- LCD panel has sharp edges, please handle with care.
- Never attempt to disassemble or rework LCD module.
- If display panel is damaged and liquid crystal substance leaks out, be sure not to get any in your mouth, if the substance comes into contact with your skin or clothes promptly wash it off using soap and water.

8. CTP Mounting Instructions

8.1 Bezel Mounting (Figure 1)

- The bezel window should be bigger than the CTP active area. It should be $\geq 0.5\text{mm}$ each side.
- Gasket should be installed between the bezel and the CTP surface. The final gap should be about $0.5\sim 1.0\text{mm}$.
- It is recommended to provide an additional support bracket for backside support when necessary (e.g. slim type TFT module without mounding structure). They should only provide appropriate support and keep the module in place.
- The mounting structure should be strong enough to prevent external uneven force or twist act onto the module.

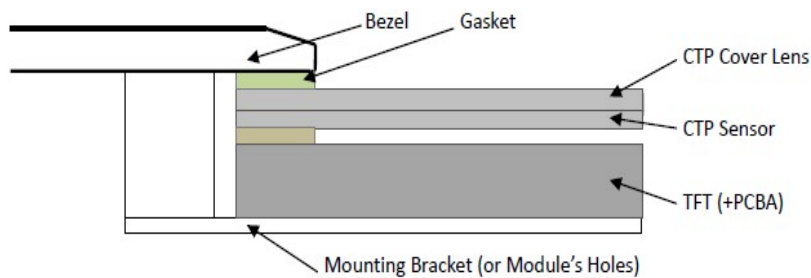

Figure 1

8.2 Surface Mounting (Figure 2)

- As the CTP assembling on the countersink area with double side adhesive. The countersink area should be flat and clean to ensure the double side adhesive installation result.
- The Bezel is recommend to keep a gap ($\geq 0.3\text{mm}$ each side) around the cover lens for tolerance.
- It is recommended to provide an additional support bracket with gasket for backside support when necessary (e.g. TFT module without mounding structure). They should only provide appropriate support and keep the module in place.
- The mounting structure should be strong enough to prevent external uneven force or twist act onto the module

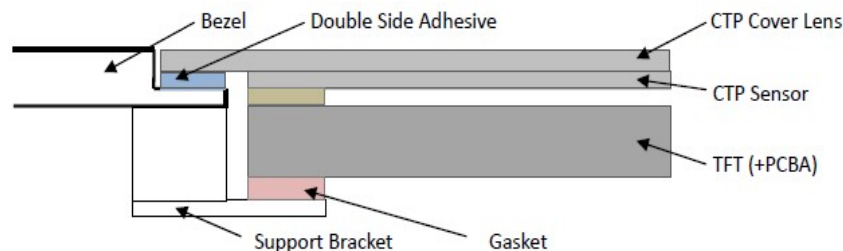

Figure 2

8.3 Additional Cover Lens Mounting (Figure 3)

- For the case of additional cover Lens mounting, it is necessary to

- 因液晶显示屏表面的偏光片极易划伤，安装完成之前请尽量不要揭下保护膜。
- 请缓慢揭除保护膜，在此过程中液晶显示屏上可能会产生静电，此为正常情况，可在短时间内消失。

- 请注意避免被液晶显示屏的边缘割伤。
- 请不要试图拆卸或改造液晶显示模块。
- 当液晶显示屏出现破裂，内部液晶液体可能流出；相关液体不可吞吃，绝对不可接触嘴巴，如接触到皮肤或衣服，请使用肥皂与清水彻底清洗。

8. 电容触摸屏安装指导

8.1 面框安装（附图 1）

- 客户面框窗口应大于 CTP 动作区域，各边离动作区应 $\geq 0.5\text{mm}$ 。
- 面框与 CTP 面板间应垫有胶垫，其最终间隙约为 $0.5\sim 1.0\text{mm}$ 。
- 建议必要时在背面提供附加支架（例如无安装结构的薄型 TFT 模块），应仅利用适当支撑以保持模块位置。
- 安装结构应具有足够的强度，以防止外部不均匀力或扭曲力作用到模块上。

8.2 嵌入安装（附图 2）

- 客户面框应具有使用双面胶粘贴 CTP 的结构沉台面，其粘贴面要求平整且洁净无污以保证粘贴牢靠。
- 考虑到制作误差，建议面框与 CTP 盖板之间四周留有 $\geq 0.3\text{mm}$ 间隙。
- 建议必要时在背面提供垫有胶垫附加支架（例如无安装结构的 TFT 模块），应仅利用适当支撑以保持模块位置。
- 安装结构应具有足够的强度，以防止外部不均匀力或扭曲力作用到模块上。

8.3 覆加盖板（附图 3）

- 需要覆加玻璃盖板的安装，为确保其功能，有必要查

recheck with the CTP specification about the material and thickness to ensure the functionality.

- It should keep a 0.2~0.3mm gap between the cover lens and the CTP surface..
- The cover lens window should be bigger than the active area of the CTP.It should be $\geq 0.5\text{mm}$ each side.
- It is recommended to provide an additional support bracket for backside support when necessary (e.g. slim type TFT module without mounding structure). They should only provide appropriate support and keep the module in place.
- The mounting structure should be strong enough to prevent external uneven force or twist act onto the module.

看产品规格书中有关盖板材料和厚度的说明。

- 玻璃盖板与 CTP 表面之间应留有 0.2~0.3mm 间隙。
- 玻璃盖板视窗应大于 CTP 动作区域，各边离动作区 $\geq 0.5\text{mm}$ 。
- 建议必要时在背面提供附加支架(例如无安装结构的薄型 TFT 模块)，应仅利用适当支撑以保持模块位置。
- 安装结构应具有足够的强度，以防止外部不均匀力或扭曲力作用到模块上。

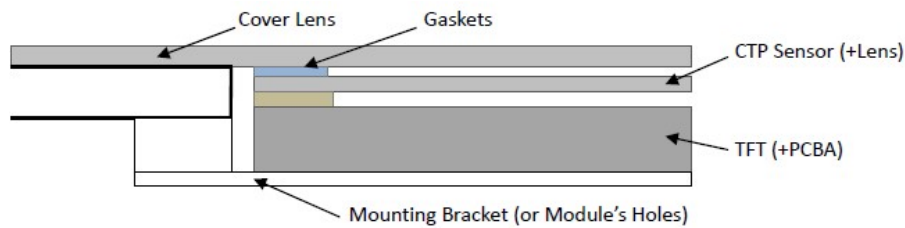

Figure 3

9. RTP Mounting Instructions

- It should bezel touching the RTP Active Area (A.A.) to prevent abnormal touch.It should left gab $D=0.2\sim 0.3\text{mm}$ in between. (Figure 4)
- Outer bezel design should take care about the area outside the A.A. Those areas contain circuit wires which is having different thickness. Touching those areas could de-form the ITO film. As a result bezel the ITO film be damaged and shorten its lifetime. It is suggested to protect those areas with gasket (between the bezel and RTP).The suggested figures are $B\geq 0.50\text{mm}$; $C\geq 0.50\text{mm}$. (Figure 4)
- The bezel side wall should keep space $E=0.2\sim 0.3\text{mm}$ from the RTP. (Figure 4)

9. 电阻触摸屏安装指导

- 为避免面框直接压在动作区 (A. A.) 上造成误动作，面框与电阻触摸屏 (RTP) 之间应留有一定的空隙 $D=0.2\sim 0.3\text{mm}$ 之间. (附图 4)
- 设计面框时，要注意用面框保护触摸屏四周的非保证操作区域，因为布线区域在此处形成一台阶，在此区域附近操作时 ITO Film 变形较大，容易导致 ITO 损坏而降低寿命。为保护 RTP 和避免误操作，在 RTP 与面框之间垫缓冲物 (Gasket)，我们建议设计面框应覆盖动作区的边缘，面框边缘到 V. A. 区的距离 $B\geq 0.50\text{mm}$ ；垫圈内边缘到 V. A. 区的距离 $C\geq 0.50\text{mm}$ 。 (附图 4)
- 在设计面框与 RTP 组装时，应考虑到面框内侧与 RTP 外侧的间距 $E\geq 0.2\text{mm}$ 。 (附图 4)

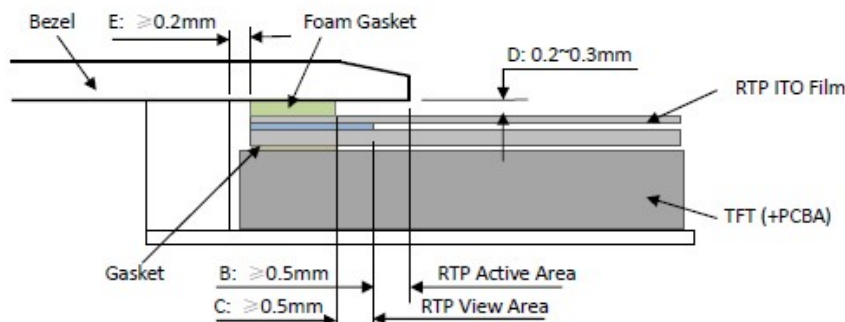

Figure 4

- In general design, RTP V.A. should be bigger than the TFT V.A. and RTP A.A. should be bigger than the TFT A.A. (Figure 5)

- 通常设计时：
RTP 的可视区 V. A. 应不小于 TFT 的可视区 V. A. 及 RTP 的动作区 A. A. 应不小于 TFT 的动作区 A. A. (附图 5)

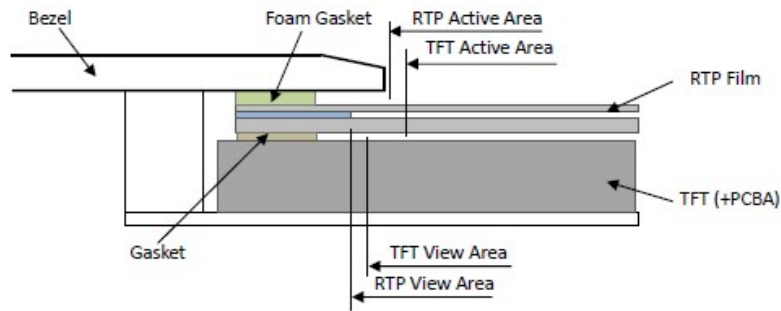
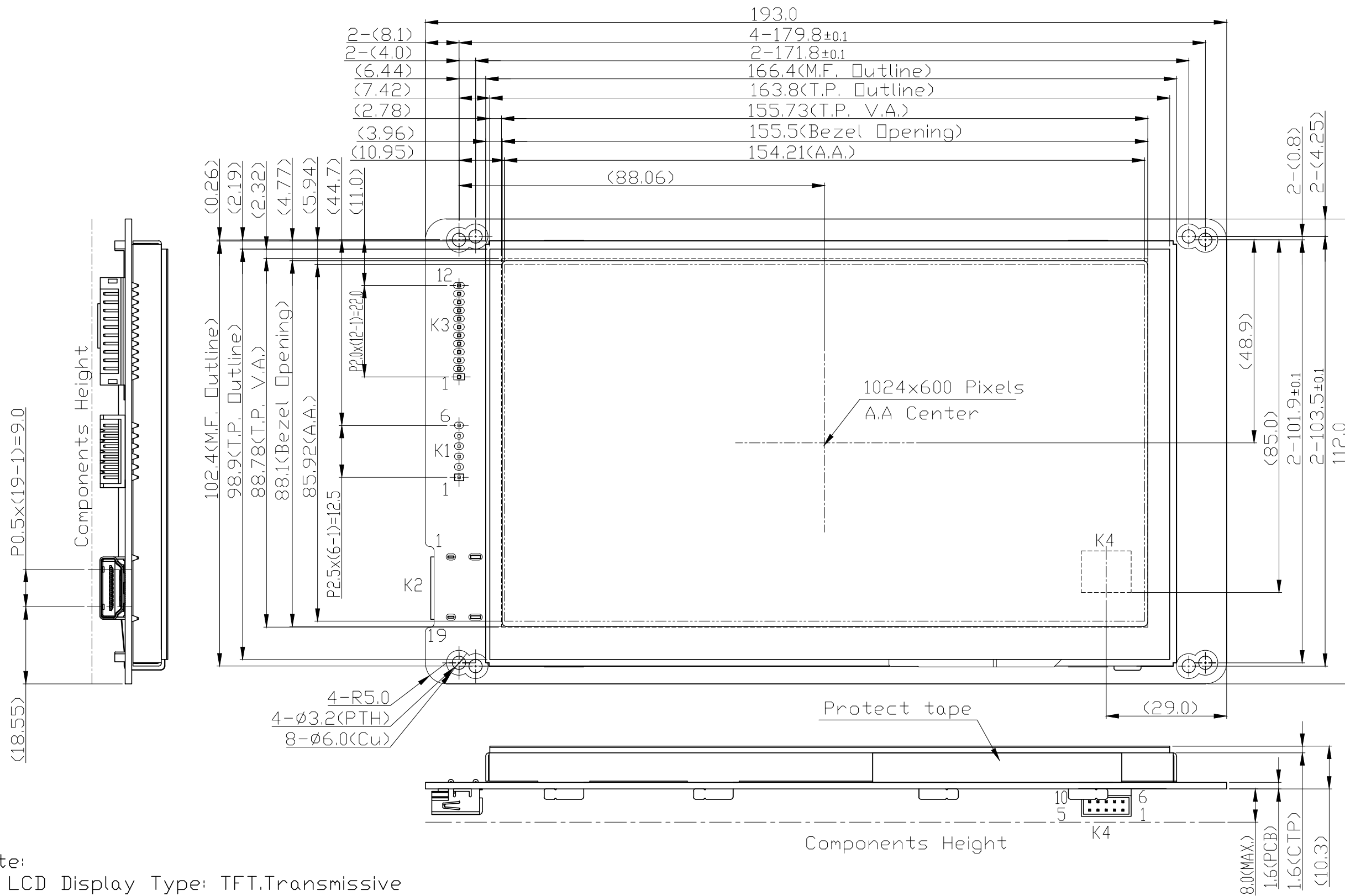

Figure 5

Warranty

This product has been manufactured to our company's specifications as a part for use in your company's general electronic products. It is guaranteed to perform according to delivery specifications. For any other use apart from general electronic equipment, we cannot take responsibility if the product is used in medical devices, nuclear power control equipment, aerospace equipment, fire and security systems, or any other applications in which there is a direct risk to human life and where extremely high levels of reliability are required. If the product is to be used in any of the above applications, we will need to enter into a separate product liability agreement.

- We cannot accept responsibility for any defect, which may arise from additional manufacturing of the product (including disassembly and reassembly), after product delivery.
- We cannot accept responsibility for any defect, which may arise after the application of strong external force to the product.
- We cannot accept responsibility for any defect, which may arise due to the application of static electricity after the product has passed our company's acceptance inspection procedures.
- When the product is in CCFL models, CCFL service life and brightness will vary according to the performance of the inverter used, leaks, etc. We cannot accept responsibility for product performance, reliability, or defect, which may arise.
- We cannot accept responsibility for intellectual property of a third part, which may arise through the application of our product to our assembly with exception to those issues relating directly to the structure or method of manufacturing of our product.



K2 Terminal	
No	Pin Name
1	TMDS_D2+
2	TMDS_D2+Shield
3	TMDS_D2-
4	TMDS_D1+
5	TMDS_D1+ Shield
6	TMDS_D1-
7	TMDS_D0+
8	TMDS_D0+Shield
9	TMDS_D0-
10	TMDS_Clock+
11	TMDS_Clock Shield
12	TMDS_Clock-
13	NC
14	NC
15	SCL_HDMI
16	SDA_HDMI
17	GND
18	+5V_Power
19	Hot_Plug_Detect

K3 Terminal	
No	Pin Name
1	GND
2	VS
3	HS
4	GND
5	Signal-R
6	GND
7	Signal-G
8	GND
9	Signal-B
10	GND
11	SDA
12	SCL

- Note:
- *1. LCD Display Type: TFT,Transmissive
 - *2. Pixel Arrangement: RGB-STRIPE
 - *3. Operating Voltage : 12.0V
 - *4. Color Depth : 16.7M (24bit)
 - *5. Backlight : White LED
 - *6. Signal Interface: VGA/HDMI
 - *7. K1: 6Pin, JST-06HR-6S-P-N or equivalent
K2: 19Pin, HDMI A TYPE
K3: 12Pin, JST B12B-PH-K-S or equivalent
K4: 2x5Pin P2.0 mini IDC header
 - *8. Touch Panel Type : Capacitive Touch Panel
 - *9. Operating Temperature : 0°C~50°C
 - *10. Storage Temperature : -10°C~60°C
 - *11. Applicable cover panel/cover glass thickness = 2.0MAX.(Without air gap)
 - *12. Unmarked Tolerance : ≤150,±0.3; >150,±0.5

K1 Terminal	
No	Pin Name
1	VDD
2	VDD
3	NC
4	NC
5	GND
6	GND

K4 Terminal	
No	Pin Name
1	GND
2	VCC
3	GND
4	D+
5	D-
6	NC
7	NC
8	NC
9	NC
10	NC

C		
B		
A	Revise Top&Tst Revise K4 Terminal	Luo Lin 2019-08-07
Rev/Note		Date
Dwg Title	LMT070DAMFWA-NFD Outline Dwg	
Dwg No.	MK-006676a-1-1	Date 2019-07-18
Scale	Tol.	Unit mm Paper Size A3
1/1		
Approved	Checked	Drawn Luo Lin

