

# TM624 TIME SWITCH

## Instruction Manual

### 1 Purpose and Scope

TM624 TIME SWITCH of Belling apparatus, control circuit with AC 50Hz/60Hz, rated control power voltage of 220V at most and rated working current of 3A at most, turn on or off the circuit with a predetermined program, for example: As a school, factory bell controller.

The product complies with the requirements of IEC 60947-5-1 standard.

### 2 Normal Operating Condition and Installation Condition

2.1 Rated control power voltage: AC (50Hz): 220V.

2.2 Conventional thermal current: 16A.

2.3 Rated working current ( $I_e$ ): AC-15 220V 3A.

2.4 Timing error:  $\leq 1s/d$ .

2.5 Bell set: 40 groups.

2.6 Belling time: 1s~99s。

2.7 Electric endurance:  $\geq 10,000$  times.。

2.8 Installation method: 35DIN Rail mounting or Screws.

### 3 Outline, Installation Dimension and Wiring Method

3.1 Outside dimension and installation dimension see Figure 1.

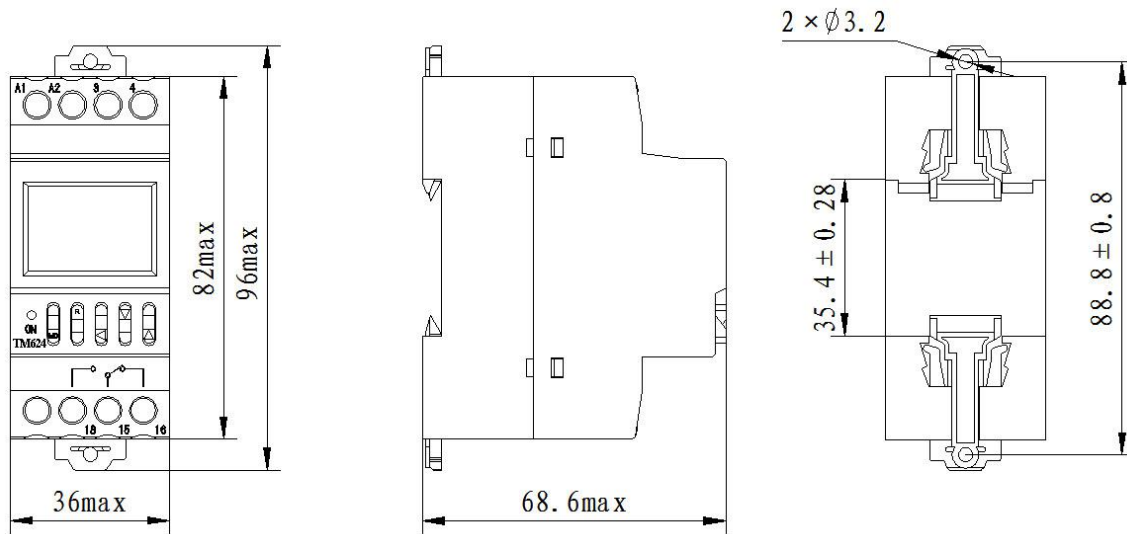

a) TM624 outside dimension

b) TM624 installation dimension

Figure 1 Outside dimensions and installation dimensions of TM624

### 3.2 Wiring method

#### 3.2.1 Direct control method

Power of the controlled appliance is supplied in single-phase, of which the working current is no more than the rated value of this switch. Direct control method may be adopted, wiring method see Figure 2; for light load with great starting current impact, please adopt AC contactor expansion control method.

#### 3.2.2 Single-phase expansion method

The controlled appliance is power supplied in single-phase, of which the working current exceeds the rated value of this switch. Please adopt AC contactor expansion control method, see Figure 3.

#### 3.2.3 Three-phase operating method

Power of the controlled appliance is supplied in three-phase, so external AC contactor is required hereof.

- a) The coil voltage of the controlled contactor is AC 220V 50Hz, so its wiring method sees Figure 4;  
 b) The coil voltage of the controlled contactor is AC 380V 50Hz, so its wiring method sees Figure 5.

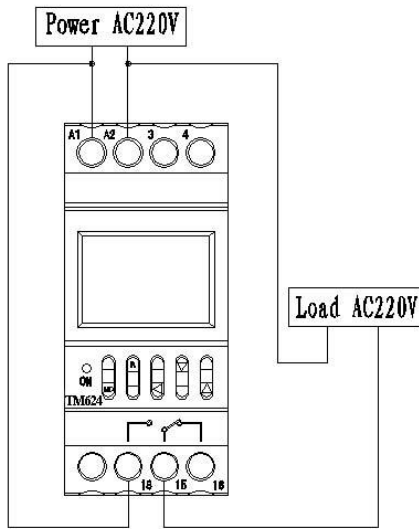

Figure 2 Direct single-phase controlled wiring diagram

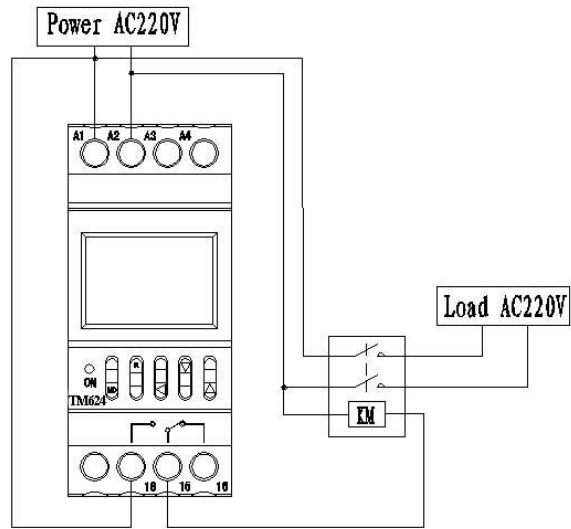

Figure 3 Single-phase expansion controlled wiring diagram

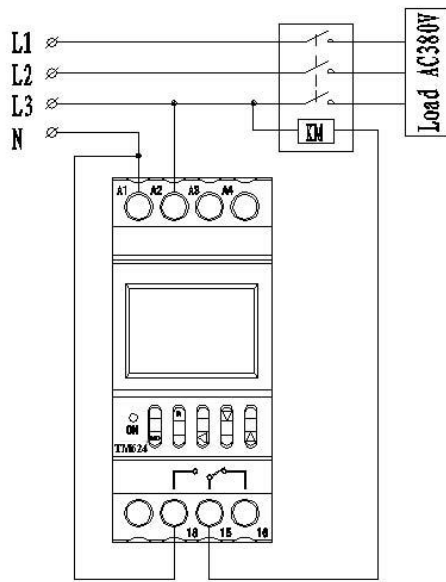

Figure 4 Three-phase controlled wiring diagram (220V for contactor coil)

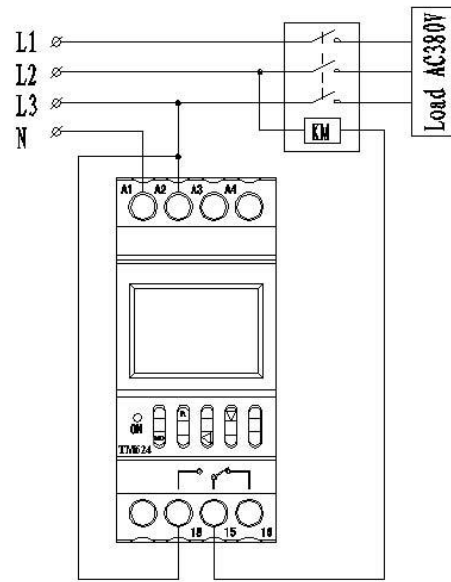

Figure 5 Three-phase controlled wiring diagram (380V for contactor coil)

#### 4 Setting and Use

This product panel is set with five buttons, namely “MD (mode)”, “R (recall)”, “◀ (left-shift)”, “▼” (-) and “▲” (+).

##### 4.1 Setting process for Time Switch of Belling apparatus parameters (see Figure 6).

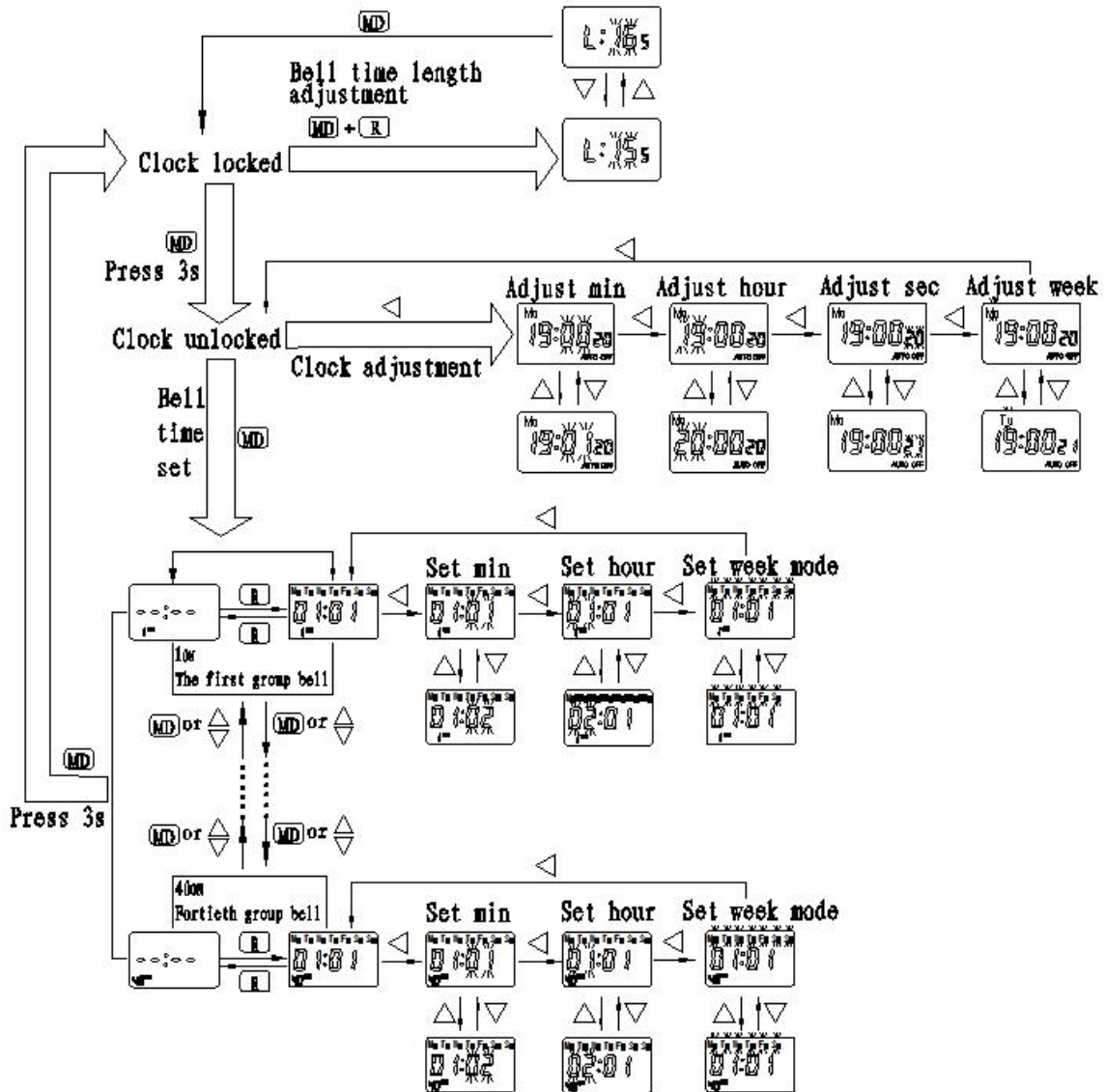

Figure6 TM624 TIME SWITCH of Belling apparatus Setting process

4.2 Setting processes are as follows:

4.2.1 Current date and current time adjustment

4.2.2.1 Press button “MD” for 3s to cancel the keyboard lockout, so that “LOCK” may disappear,

Press “◀” to select the adjusted position and press “-” and “+” to plus and minus, so as to adjust the display time to the current time, see Figure 7.

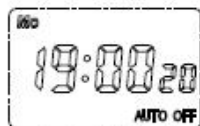

Figure 7

4.2.3 Timing parameters setting

4.2.3.1 After finish operation 4.2.2, press “MD” + “R” to Setting rang the bell time, see Figure 8, It means long rang the bell for 15 seconds. After setting, press "MD" key to exit.



Figure8

4.2.3.2 Set 1ON (first group of bell) time: press the "MD" key to enter first bell time set, respectively, according to "◀" turn into minutes, hours, weeks mode setting, then set bit flashes, such as Figure9, press the "+" " - " buttons to set Working clock, The days will work on behalf of the week mode of light. After setted, Press "MD" key to enter 2ON (second group of bell) time set.

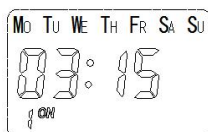

Figure9

4.2.3.3 Set 2ON (second group of bell) time:same steps as 4.2.3.2, such as Figure10.

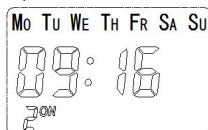

Figure10

4.2.3.4 Repeat the above steps to Complete all bell time settings,press the "R" key to elimination the Groups do not need , then LCD display "◦ ◦ ◦ ◦", As shown in Figure11, again press the "R" button can recall the setted.

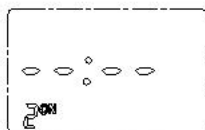

Figure11

4.2.4 When the setting is completed, press the "MD" key for 3 seconds to enter the clock state, Time Switch of Belling apparatus automatically locked "LOCK" character, as Figure12 shows.



Figure12

4.3 After locking the switch, press "MD" and "+" at the same time to switch manual/automatic status. Continuously press them together, the screen will show "AUTO OFF", "ON", "ON AUTO" and "OFF" successively, see Figure 13. When the circuit shall be on and off temporarily in the process of operation, the combination buttons can be used to adjust the switch to ON and OFF; if the time switch shall work automatically according to the set time, the combination button shall be used to adjust the switch to "ON AUTO", then the time switch may work as set, so as to achieve automatic control.

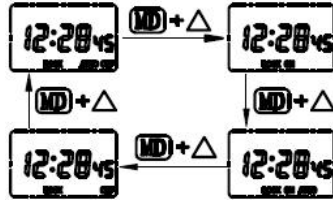

Figure 13 Manual/automatic time switch setting process

## 5 Notice

5.1 The switch into the line can only be connected to AC220V power supply, do not access the other power.

5.2 If you can not achieve automatic control function, Check the lower right corner of the screen (AUTO) is right shown?

5.3 The internal battery can only provide the LCD screen display and settings, such as A1, A2 terminal auxiliary power missed, is unable to drive the relay output.

5.4 If the user find errors in the products, Through short 3, 4 terminal reset, After reset procedures need to set again.

5.5 When the end of the product life, please recycle work product or its components, for not recycled parts, please dispose of, to protect our environment.

---