



## S8550

## PNP SILICON TRANSISTOR

### LOW VOLTAGE HIGH CURRENT SMALL SIGNAL PNP TRANSISTOR

#### DESCRIPTION

The UTC **S8550** is a low voltage high current small signal PNP transistor, designed for Class B push-pull audio amplifier and general purpose applications.

#### FEATURES

- \* Collector current up to 700mA
- \* Collector-Emitter voltage up to 20 V
- \* Complementary to UTC S8050

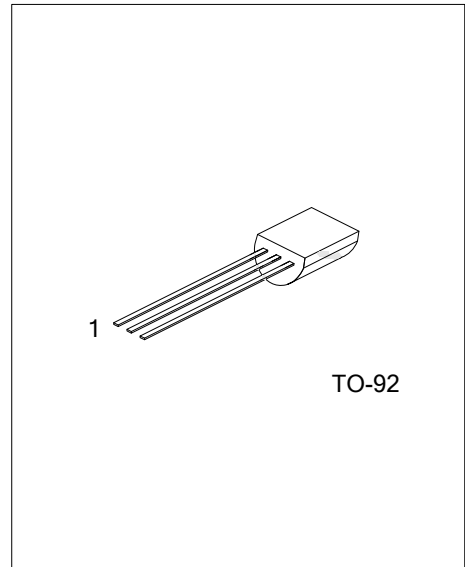

#### ORDERING INFORMATION

Order Number		Package	Pin Assignment			Packing
Lead Free Plating	Halogen Free		1	2	3	
S8550L-x-T92-B	S8550G-x-T92-B	TO-92	E	B	C	Tape Box
S8550L-x-T92-K	S8550G-x-T92-K	TO-92	E	B	C	Bulk

<p>S8550L-x-T92-B</p> <p>(1)Packing Type (2)Package Type (3)Rank (4)Lead Plating</p>	<p>(1) B: Tape Box, K: Bulk (2) T92: TO-92 (3) x: refer to Classification of <math>h_{FE2}</math> (4) L: Lead Free, G: Halogen Free</p>
--	---

#### MARKING

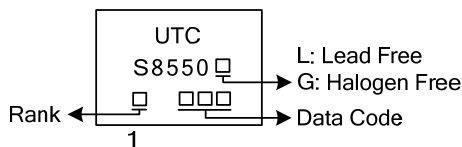

■ ABSOLUTE MAXIMUM RATING ( $T_A=25^\circ\text{C}$ , unless otherwise specified.)

PARAMETER	SYMBOL	RATINGS	UNIT
Collector-Base Voltage	$V_{CBO}$	-30	V
Collector-Emitter Voltage	$V_{CEO}$	-20	V
Emitter-Base Voltage	$V_{EBO}$	-5	V
Collector Current	$I_C$	-700	mA
Collector Dissipation ( $T_A=25^\circ\text{C}$ )	$P_C$	1	W
Junction Temperature	$T_J$	150	$^\circ\text{C}$
Storage Temperature	$T_{STG}$	-65 ~ +150	$^\circ\text{C}$

Note: Absolute maximum ratings are those values beyond which the device could be permanently damaged. Absolute maximum ratings are stress ratings only and functional device operation is not implied.

■ ELECTRICAL CHARACTERISTICS ( $T_A=25^\circ\text{C}$ , unless otherwise specified.)

PARAMETER	SYMBOL	TEST CONDITIONS	MIN	TYP	MAX	UNIT
Collector-Base Breakdown Voltage	$BV_{CBO}$	$I_C = -100\mu\text{A}$ , $I_E = 0$	-30			V
Collector-Emitter Breakdown Voltage	$BV_{CEO}$	$I_C = -1\text{mA}$ , $I_B = 0$	-20			V
Emitter-Base Breakdown Voltage	$BV_{EBO}$	$I_E = -100\mu\text{A}$ , $I_C = 0$	-5			V
Collector Cut-Off Current	$I_{CBO}$	$V_{CB} = -30\text{V}$ , $I_E = 0$			-1	$\mu\text{A}$
Emitter Cut-Off Current	$I_{EBO}$	$V_{EB} = -5\text{V}$ , $I_C = 0$			-100	nA
DC Current Gain	$h_{FE1}$	$V_{CE} = -1\text{V}$ , $I_C = -1\text{mA}$	100			
	$h_{FE2}$	$V_{CE} = -1\text{V}$ , $I_C = -150\text{mA}$	120		400	
	$h_{FE3}$	$V_{CE} = -1\text{V}$ , $I_C = -500\text{mA}$	40			
Collector-Emitter Saturation Voltage	$V_{CE(SAT)}$	$I_C = -500\text{mA}$ , $I_B = -50\text{mA}$			-0.5	V
Base-Emitter Saturation Voltage	$V_{BE(SAT)}$	$I_C = 500\text{mA}$ , $I_B = -50\text{mA}$			-1.2	V
Base-Emitter Saturation Voltage	$V_{BE}$	$V_{CE} = -1\text{V}$ , $I_C = -10\text{mA}$			-1.0	V
Current Gain Bandwidth Product	$f_T$	$V_{CE} = -10\text{V}$ , $I_C = -50\text{mA}$	100			MHz
Output Capacitance	$C_{ob}$	$V_{CB} = 10\text{V}$ , $I_E = 0$ , $f = 1\text{MHz}$		9.0		pF

■ CLASSIFICATION OF  $h_{FE2}$

RANK	C	D	E
RANGE	120-200	160-300	280-400

■ TYPICAL CHARACTERISTICS

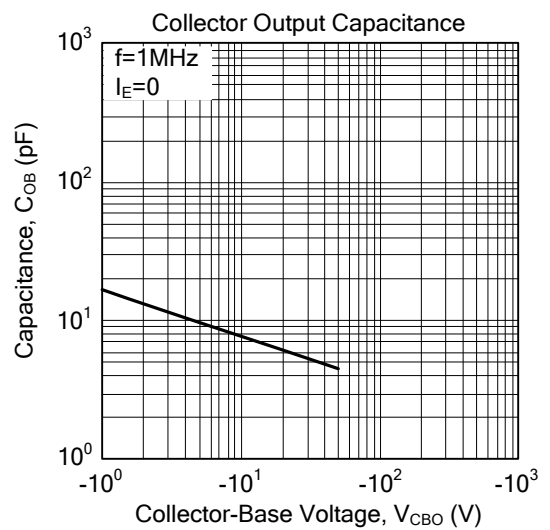
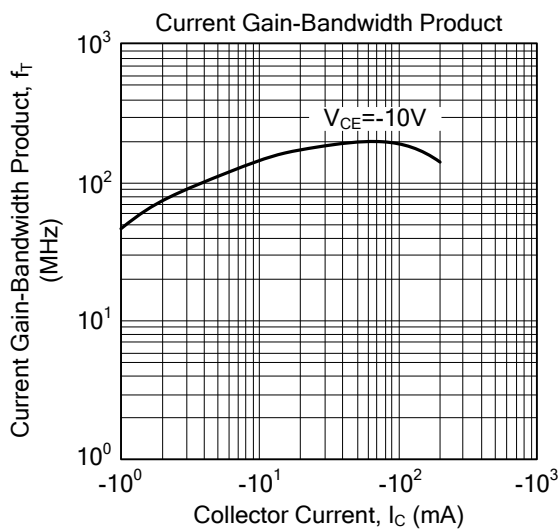
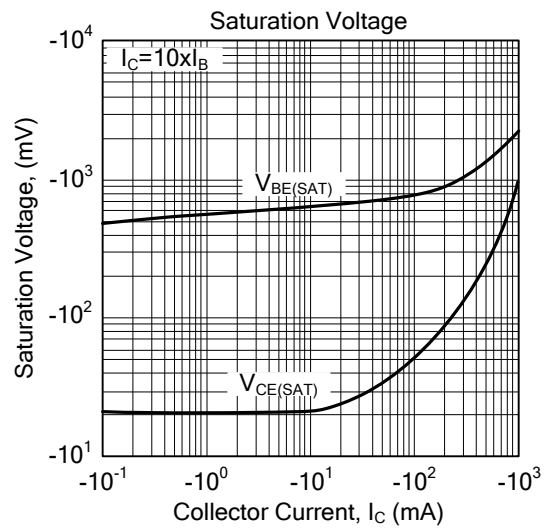
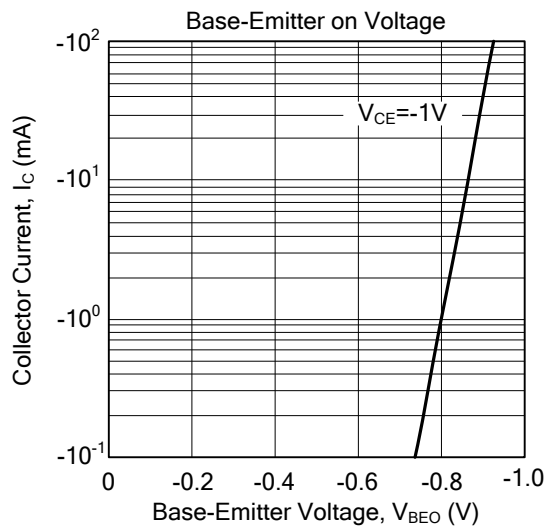
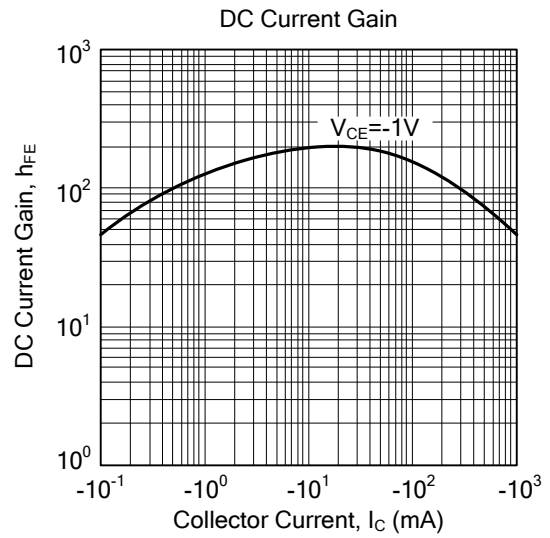
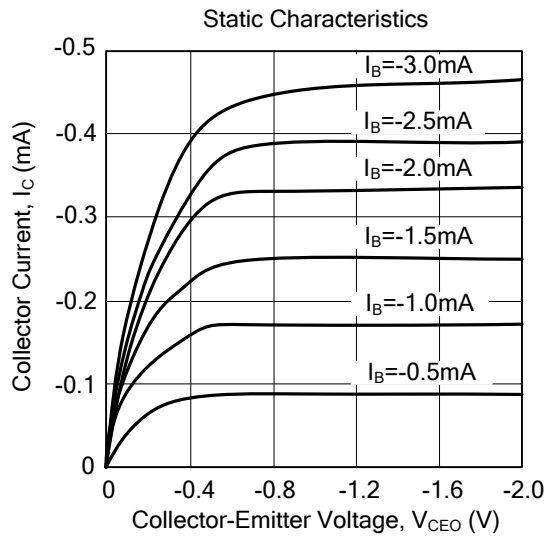

UTC assumes no responsibility for equipment failures that result from using products at values that exceed, even momentarily, rated values (such as maximum ratings, operating condition ranges, or other parameters) listed in products specifications of any and all UTC products described or contained herein. UTC products are not designed for use in life support appliances, devices or systems where malfunction of these products can be reasonably expected to result in personal injury. Reproduction in whole or in part is prohibited without the prior written consent of the copyright owner. The information presented in this document does not form part of any quotation or contract, is believed to be accurate and reliable and may be changed without notice.